

# COLT LIGHT RIFLE



OWNER'S MANUAL

## TABLE OF CONTENTS

Introduction .....	1
Precautions .....	2
Safety Instructions .....	4
General Safety Rules .....	10
Colt Service Policy and Warranty .....	11
Exploded Assembly View .....	12
Parts List .....	13
Limitation .....	14
Operating Instructions .....	15
Unloading the Firearm .....	16
Cleaning Your Firearm .....	17
Using Authorized Parts .....	18
How To Obtain Service .....	19
Shipping Your Firearm .....	20
Troubleshooting .....	21

# INTRODUCTION

We in the Colt Family want to thank you for your purchase of a Colt firearm.

We realize that there are many choices you could have made. By buying a Colt product, we feel that you have purchased the finest quality firearm produced on the market today.

When Sam Colt started his company in the 1800's, he and his firearms played a prominent role in the history of a developing America. So popular was the Colt revolver, it was the best-known firearm, not only in this country, but also in Canada, Mexico, and many European countries.

Colt has always been committed to the hunter and shooter by delivering a safe and uncompromised craftsmanship value that you would expect from a Colt firearm.

We hope you enjoy your Colt Light Rifle.

# PRECAUTIONS

**READ AND UNDERSTAND ALL THE FOLLOWING PRECAUTIONS BEFORE REMOVING THIS FIREARM FROM ITS PACKAGE.**

This Colt product is classified by the Alcohol, Tobacco and Firearms Division of the Internal Revenue Service, U.S. Treasury Department as a firearm or dangerous weapon. It is, therefore, potentially lethal!

**⚠ WARNING: IF THIS FIREARM IS CARELESSLY OR IMPROPERLY HANDLED, DISCHARGE COULD RESULT AND COULD CAUSE INJURY, DEATH, OR DAMAGE TO PROPERTY.**

**⚠ CAUTION: CAREFULLY READ THIS INSTRUCTION MANUAL PRIOR TO LOADING AND FIRING; IT GIVES BASIC ADVICE ON THE PROPER HANDLING AND FUNCTIONING OF THIS COLT FIREARM.** However, your safety and the safety of others (including your family) depends on your mature compliance with that advice and your adoption, development and constant employment of safe practices. If unfamiliar with firearms, seek further advice through safe handling courses run by your local gun clubs, a NRA-approved instructor, or similar qualified organizations.

## **NOTICE**

Colt shall not be responsible for injury, death, or damage to property resulting from either intentional or accidental discharge of this firearm, or from its function when used for purposes or subjected to treatment for which it was not designed. Colt will not honor claims involving this firearm which result from careless or improper handling, unauthorized adjustment or parts replacement, corrosion, neglect, or the use of wrong caliber ammunition, or the use of anything other than original high-quality commercially manufactured ammunition in good condition, or any combination thereof. Colt will not honor claims involving this firearm for any reason or cause when such claims are made by the second or subsequent owner.

# PRECAUTIONS

## **IMPORTANT**

Before it left the factory, this firearm was tested and carefully inspected. Colt cannot control product handling after it leaves the factory; therefore, please examine this firearm carefully at the time of purchase to ensure that it is unloaded and undamaged. The dealer will be pleased to assist you in making this examination and will endeavor to answer any further questions. This instruction manual should always accompany this firearm. If you lend, give or sell this firearm, be sure that this manual goes with it.

 **CAUTION: USE ONLY CLEAN, DRY, ORIGINAL HIGH-QUALITY COMMERCIALY MANUFACTURED AMMUNITION THAT IS IN GOOD CONDITION** and is appropriate to the caliber of your firearm. We do not recommend the use of remanufactured or hand-loaded ammunition, because it may severely damage your rifle.

### Rifle Chambered For:

.300 Win. Mag.  
7mm Rem. Mag.  
.280 Rem.  
.270 Win.  
.308 Win.  
7mm.08 Rem.  
.243 Win.  
7x57 Mauser  
.260 Rem.  
30-06 Sprg.  
25-06 Rem.

### Suitable Ammunition

.300 Win. Mag.  
7mm Rem. Mag.  
.280 Rem.  
.270 Win.  
.308 Win. / NATO 7.62mm  
7mm.08 Rem.  
.243 Win.  
7x57 Mauser  
.260 Rem.  
30-06 Sprg.  
25-06 Rem.

# SAFETY INSTRUCTIONS

We want you to enjoy shooting your Colt rifle, but we want you to enjoy it safely. You may be an experienced, safe shooter already familiar with the procedures in this manual, or you may have never handled a gun before. Either way, we urge you to read this entire instruction manual carefully. You must follow the safety instructions, for your own safety and the safety of others.

 **WARNING:** when you squeeze the trigger, you must expect the gun to fire, and you must take full responsibility for firing it. Your care can avoid accidental discharge, and you will thereby avoid accidental injury and death.

 **WARNING:** THIS FIREARM MAY DISCHARGE ACCIDENTALLY WHEN A ROUND IS FED INTO THE CHAMBER, IF IT IS DROPPED OR RECEIVES A BLOW TO THE MUZZLE, FRONT, OR REAR OF THE GUN. This can occur regardless of any of the various safety devices. Therefore, extra care and adherence to these instructions is mandatory for minimizing the risk of accidents.

## GENERAL HANDLING CAUTIONS

1. Always handle your firearm as if it were loaded so that you never fire it accidentally when you think it is unloaded.
2. Never point your firearm at anything you do not intend to shoot so that if it fires accidentally, injury, death, or damage to property will be prevented.
3. Never take anyone's word that a gun is unloaded; check for yourself with fingers off the trigger and the gun pointed in a safe direction, so that you never fire the gun accidentally.
4. Always make sure that your firearm is not loaded and that the bolt is latched open before laying it down or handing it to another person, so that it cannot be fired when it is unsafe to do so.
5. Always keep and carry your firearm empty, except when you intend to shoot, so that your firearm cannot be fired accidentally.

## SAFETY INSTRUCTIONS

6. Always be aware of possible risk from dropping your firearm. Some parts of the mechanism could be damaged. You may not see the damage, but if it is severe the firearm may discharge and cause injury, death, or damage to property. If your firearm has been dropped, have it examined by a competent gunsmith before using it again.
7. Never leave a firearm cocked and ready to fire as this condition is extremely dangerous. The firearm could be accidentally discharged and cause injury, death, or damage to property.
8. Never leave a loaded firearm unattended. Someone, especially a child, may fire it and cause injury, death, or damage to property.
9. Always instruct children and others in your household to respect firearms. If you teach your children to shoot, or if you have them trained by a qualified instructor, teach them to treat and use the firearm properly. Supervise them closely and always stress safety, so that your children will not fire the firearm when it is unsafe to do so.

### RANGE CAUTIONS

10. Always be sure that your backstop is adequate to stop and contain bullets before you begin target practice, so that you do not hit anything outside the range shooting area.
11. Always put a knowledgeable and responsible person in charge, to maintain safety control when a group is firing on a range. Obey their commands so that discipline is maintained, to reduce the likelihood of accidents.
12. Always carry your firearm empty with the bolt open while on a range until preparing to fire. Keep it pointed toward the backstop when loading, firing and unloading, to eliminate the risk of injury, death, or damage to property due to premature discharge.

### LOADING CAUTIONS

13. Always be sure that the barrel bore, chamber and action are clean and clear of obstructions. Clean a wet or fouled firearm immediately, so that it will function correctly and safely.

## SAFETY INSTRUCTIONS

14. Always use only clean, dry, original high-quality commercially manufactured ammunition that is in good condition and appropriate to the caliber of your firearm. Gun and ammunition manufacturers design their products within exacting engineering safety limits. Handloads and remanufactured ammunition are sometimes outside those limits and can be so unsafe as to blow up the chamber, damage the receiver and magazine, and cause injury, death, or damage to property and costly repairs to your rifle.
15. Always confirm that ammunition is clean and undamaged before using. Forcing damaged ammunition into the chamber could damage your rifle and result in injury, death, or damage to property.

### SHOOTING CAUTIONS

16. Never drink alcoholic beverages or take drugs before or during shooting, as your vision and judgment could be seriously impaired.
17. Always seek a doctor's advice if you are taking medication, to be sure you are fit to shoot and handle your firearm safely.
18. Always wear and encourage others to wear ear protection when shooting, especially on a range. Without ear protection, the noise from your firearm and other guns around you could leave a "ringing" in the ears for some time after firing. The cumulative long-term effect could be permanent hearing loss.
19. Always wear and encourage others to wear protective shooting glasses. Flying particles could damage the eyes and cause blindness.
20. Always keep the safety set to "Safe" when the firearm is loaded and cocked, until you are aiming at a target and are ready to fire. This will minimize the risk of an accidental discharge.
21. Always keep yourself and others clear of the ejection port. Cartridges can be ejected with enough force to cause injury, and the ejection port must be unobstructed by your hand to ensure safe ejection of live rounds.



# SAFETY INSTRUCTIONS

22. Never squeeze the trigger or put your finger in the trigger guard until you are aiming at a target and ready to shoot. This will help prevent the firearm from firing when pointed in an unsafe direction.
23. Always be absolutely sure of your target and the area behind it before you squeeze the trigger. A bullet could travel through or past your target up to three miles. If in doubt, do not shoot.
24. Never attempt to fire if water is in the barrel. Water can accumulate if your firearm is exposed to heavy rain or fog. Open the bolt and allow water to drain before firing, and clean as soon as possible.
25. Never shoot at a hard surface such as rock, or at a liquid surface such as water. A bullet may ricochet and travel in any direction to strike you or an object, causing injury, death, or damage to property.
26. Never discharge a firearm near flammable material. Flame and sparks erupt from the firearm when discharged; they could start a fire or cause flammable liquids and gases to explode.
27. Never fire your firearm near an animal unless it is trained to accept the noise. An animal's startled reaction could cause an accident.
28. Never indulge in "horseplay" while holding your firearm.
29. Never walk, climb or follow a companion with your firearm cocked and ready to fire (in battery), to eliminate risk of accidental discharge. When hunting, hold your firearm so that you can always control the direction of the muzzle, and keep the safety lever set to "safe".

## MALFUNCTION CAUTIONS

30. **A Failure To Fire:** Always hold the firearm, keeping it pointed towards the target or a safe, open area, and wait 30 seconds. If a hangfire (slow ignition) has occurred, the round should fire within 30 seconds. If the round does not fire, open the bolt, eject the round, and examine the primer; if the firing pin indent on the primer is light, off-center, or non-existent, have the firearm examined by a competent gunsmith before firing again. If the indent appears normal, assume faulty ammunition; segregate the misfired round from other live ammunition and empty cases, reload the firearm, and continue firing.

# SAFETY INSTRUCTIONS

*Note 1: Dispose of misfired rounds in accordance with the ammunition manufacturer's instructions.*

31. Never use your firearm if it fails to function properly, and never force a jammed action, as a round may explode and cause serious injury, possible death, or severe damage to your firearm.

## CLEANING AND STORAGE CAUTIONS

32. Always make sure your firearm is not loaded before cleaning and storing it, so that it cannot be fired when it is unsafe to do so.
33. Always keep and store your firearm and ammunition in separate locked receptacles, out of reach and sight of children and untrained people, to minimize the risk of the firearm and ammunition being easily accessible for loading and firing.

## GUN ABUSE CAUTIONS

34. Never abuse your firearm by using for any purpose other than shooting.
35. Never dry-fire your firearm when the receiver is open, as the level of safety could be reduced.
36. Never alter parts, as the level of safety could be reduced.

*Note: We have chosen to use the word "squeeze" in this instruction manual, instead of "pull" or "press", when trigger movement is described. This choice is simply to remind you of the need for a gentle squeezing action to achieve accuracy.*

# SAFETY INSTRUCTIONS

## AMMUNITION SELECTION

Colt firearms are designed to function with a variety of brands and types of factory-manufactured ammunition in the appropriate caliber; however, not all ammunition produces the same results. Colt recommends that after you read and understand this manual, go to the firing range and fire various brands of ammunition that are appropriate for the caliber of your firearm. Once you find the brand of ammunition that provides you with good accuracy and function, continue using that brand.

 **CAUTION:** Always confirm that the ammunition is clean and undamaged before closing the bolt. Forcing damaged ammunition into the chamber could damage your rifle and result in injury, death, or damage to property.

Use only ammunition recommended as suitable for your firearm. Examine the ammunition, particularly on and around the primer. Look for dents, scratches, and other signs of damage. Do not load damaged ammunition.

 **CAUTION:** To minimize the risk of unintentional damage, load live ammunition into your firearm only when you are about to shoot.

 **CAUTION:** Never leave your firearm cocked, loaded, and ready to fire without the safety being set to "safe". This is the "fire" condition and could be extremely dangerous; the firearm could be accidentally discharged, causing injury, death, or damage to property.

## GENERAL SAFETY RULES

**Know your firearm.** Be sure to read the entire manual, including the instructions on how to use the firearm safely and correctly.

**Always treat your firearm as if it were loaded.** Be sure that the safety lever is in the "Safe" or "Safe and Lock Bolt" position until you are ready to fire. Do not make any adjustments. Never make any changes to any parts of the gun.

**Maintain your firearm properly by keeping the barrel clean and free from obstructions.** Clean and inspect all parts of the firearm periodically, to make sure its mechanisms function properly.

**Always keep the muzzle pointed in a safe direction.** Never point a firearm at anyone.

**Use only the cartridge inscribed on the barrel.**

**Handloads can be dangerous.** Colt will not be responsible for accidents or damage caused by handloads.

**Unload your firearm when not in use.** Never store a loaded firearm in any building or vehicle.

**Never leave your firearm accessible to children, or to people that have not been properly trained to safely handle a firearm.**

# COLT SERVICE POLICY

Welcome to the Colt family! You are now the proud owner of a Colt firearm, which has been synonymous with quality firearms for more than 160 years.

We at Colt have so much confidence in our products that we provide a lifetime service agreement. Colt will repair any unserviceable part(s) of your Colt firearm. However, cosmetic corrections will only be made during the first year after purchase. We will consider requests for service or repair of Colt firearms on a case-by-case basis. A determination will be made, taking into consideration such things as the age and condition of the firearm and the circumstances surrounding its malfunction or other problem.

## WARRANTY STATEMENT

Based on the Magnum-Moss Warranty Act, Colt offers no express warranty on its product line. However, Colt recognizes its obligations concerning implied warranty. Colt also stands behind its products, as it has historically, and will continue to provide services to its product line as it has over the years. Colt products will be serviced for a period of one year from the date of retail purchase, for defects in materials or workmanship, at no charge to the purchaser. BE SURE to retain your sales slip as proof of purchase date when making a claim.

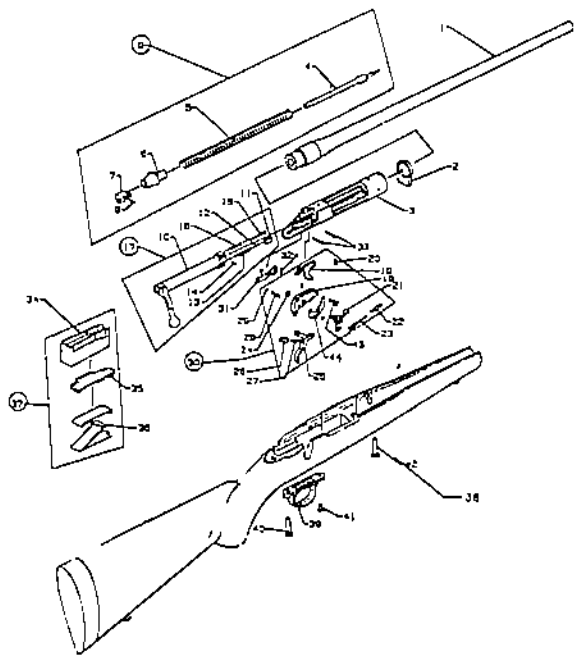

## PARTS LIST

- |     |                     |     |                             |
|-----|---------------------|-----|-----------------------------|
| 1.  | Barrel              | 23. | Plunger                     |
| 2.  | Barrel Lug          | 24. | Safety Retaining Ring       |
| 3.  | Receiver            | 25. | Trigger                     |
| 4.  | Firing Pin          | 26. | Trigger Spring              |
| 5.  | Firing Pin Spring   | 27. | Trigger Spring Post         |
| 6.  | Bolt Sleeve         | 28. | Trigger Pivot Pin           |
| 7.  | Cocking Piece       | 29. | Trigger Retaining Ring      |
| 8.  | Firing Pin Crosspin | 30. | Trigger Assembly            |
| 9.  | Firing Pin Assembly | 31. | Bolt Stop                   |
| 10. | Bolt                | 32. | Bolt Stop Spring (not used) |
| 11. | Extractor           | 33. | Front and Rear Housing Pin  |
| 12. | Plunger, Extractor  | 34. | Magazine Box                |
| 13. | Extractor Spring    | 35. | Magazine Follower           |
| 14. | Ejector Pin         | 36. | Magazine Follower Spring    |
| 15. | Ejector             | 37. | Magazine Box Assembly       |
| 16. | Ejector Spring      | 38. | Stock                       |
| 17. | Bolt Assembly       | 39. | Trigger Guard               |
| 18. | Trigger Housing     | 40. | Rear Trigger Guard Screw    |
| 19. | Trigger Scar        | 41. | Front Trigger Guard Screw   |
| 20. | Trigger Scar Spring | 42. | Center Guard Screw          |
| 21. | Safety Lever        | 43. | Plunger Post                |
| 22. | Safety Lever Spring | 44. | Bolt Lock                   |

## LIMITATION

Colt will not be responsible for defects resulting from ordinary wear and tear, alterations by unauthorized persons, accidents, misuse, use of incorrect or other than factory-loaded ammunition, or failure to provide reasonable and normal maintenance. This agreement will not apply to those parts of your Colt which have been "tuned or gunsmithed" for performance other than the custom tuning provided by a Colt custom gun shop. Should any Colt firearm require service or repair under this service policy, it must be delivered transportation prepaid to Colt Rifles Inc.

This agreement is not transferrable, and its benefits apply only to the original purchaser.



# OPERATING INSTRUCTIONS

The bolt assembly of your new Colt Light Rifle is packed separately in the shipping container. To install the bolt, first move the safety lever to its forward position, then fit the lugs on the forward end of the bolt into the back end of the receiver, and slide the bolt forward. The bolt handle can now be pushed forward and down to its closed position.

## SAFETY OPERATION:

The safety lever can be operated when the bolt is in its closed position, or when the bolt is removed. The forward safety lever position is the Fire position. The middle position is the Safe and Bolt Lock position; this will prevent the rifle from firing and also prevent the bolt from being moved. The rearward position is the Safe position; holding the safety lever in the Safe position will allow the bolt to be moved for unloading, while still preventing the rifle from firing. Releasing the safety lever from the Safe position will allow it to move on its own to the Safe and Bolt Lock position.

## LOADING THE RIFLE:

*Caution: The safety lever must NOT be placed in the Fire position during loading and unloading.*

*Caution: Do not use ammunition that is damaged or of the incorrect caliber.*

- While holding the safety lever in its Safe position, raise the bolt handle.
- Release the safety lever and slide the bolt rearward, exposing the magazine follower.
- Visually check the ammunition for any scratches or dents, especially near the primer. Check the caliber marked on the back of the casing, to be certain it matches the caliber of your gun.
- Load the magazine by placing one cartridge at a time into the magazine, with the bullet forward. Press down on the cartridge until it is held by the feed lips. Place the next cartridge to be loaded on top of the previous cartridge, and repeat until the desired number of cartridges is loaded.
- Push the bolt handle fully forward and down to its closed position. This will load the top cartridge into the chamber and allow the safety lever to move on its own into its Safe and Bolt Lock position.

## UNLOADING THE FIREARM

*Caution: The safety lever must NOT be placed in the Fire position during loading and unloading.*

- Always point the firearm in a safe direction.
- While holding the safety lever in its Safe position, raise the bolt handle.
- Release the safety lever and slowly slide the bolt rearward. The remaining cartridge will be ejected from the rifle.
- Close the bolt by pushing the bolt forward and down.
- Repeat the same procedure to remove all ammunition.
- Take care during this process to not allow any ammunition to hit the ground.



### **WARNING:**

This firearm, as with any firearm, may discharge accidentally if it is dropped or it receives a blow to the muzzle, front, or rear of the gun while a round is in the chamber. This may occur regardless of the position of the safety lever. Therefore, the user's extra care and strict adherence to these instructions is mandatory for minimizing the risk of accidents.

# CLEANING YOUR FIREARM

## WHEN TO CLEAN

Make sure that the magazine and chamber of the firearm are empty. Before firing, check that the barrel and chamber are dry and free of any obstructions. After firing, clean your firearm as soon as possible. This will reduce the chances of corrosion. Check your gun after a few days to confirm that no further cleaning is necessary. For optimum performance, Colt recommends a thorough cleaning after each hunting trip or trip to the shooting range.

## CLEANING THE BARREL ASSEMBLY

- While holding the safety lever in its Safe position, raise the bolt handle. Release the safety lever and slide the bolt rearward. Depress the bolt stop and remove the bolt assembly from the rear of the receiver.
- Swab with a patch wetted with Hoppes #9 or another suitable bore cleaner.
- With a cleaning brush, remove any carbon residue.
- With a cleaning rod designed for the caliber of your rifle, run a bristle brush wetted with Hoppes #9 or another suitable bore cleaner through the barrel assembly.
- After brushing, swab the barrel assembly with a patch wetted with Hoppes #9 or another suitable bore cleaner.
- Follow with a dry patch, to remove any remaining carbon. If the barrel assembly was cleaned correctly, the dry patch after swabbing should be relatively clean with little carbon showing.
- To remove any copper fouling, place on the cleaning rod a patch wetted with one of the following: Shooter's Choice, Hoppes Benchrest, Sweets 7.62, or Barnes CR-10. Swab the barrel assembly, replace the dirty patch and continue until the patches no longer show a blue-green stain. Follow up with a dry patch swabbed through the barrel assembly.
- Finally, swab the barrel assembly with a patch wetted with Hoppes Nitro Solvent, followed by a dry patch.

## BARREL BREAK-IN

Breaking in a barrel is an essential part of accuracy for any rifle. For optimum accuracy, Colt recommends thoroughly cleaning your barrel every five rounds for the first 50 rounds using the cleaning instructions in the previous section.

## USING AUTHORIZED PARTS

If you or anyone else makes unauthorized alterations or uses unauthorized parts with your firearm, Colt will not assume responsibility for its function. Your firearm is manufactured to perform properly with the original parts as designed. It is your duty to make sure that any parts you buy are installed correctly by Colt Rifles Inc., and that neither replacements nor originals are altered or changed. This is why we recommend sending your Colt firearm to Colt Rifles Inc. for service.

Your gun is a complex tool with many parts that must relate correctly to the other parts. Putting a gun together wrong or with modified parts can result in a damaged gun, danger, and injury or death to you and others through malfunction. Double-check any work you think was not performed by Colt Rifles Inc.; feel free to call our customer service department for additional help and information. We at Colt think this is a small price to pay for your safety.

## HOW TO OBTAIN SERVICE

You may obtain service for your Colt firearm at any time it is necessary. Make sure that your firearm is not loaded, then ship it to Colt Rifles Inc. Address is provided below.

For spare parts, seek advice from the dealer; they should have up-to-date information on how to best obtain genuine Colt parts. An illustration and a list of part names are included in this manual, to help you identify the part you need. It is important to note that not all parts are available for sale; those parts which are available should be installed at Colt Rifles Inc. When ordering parts, please give the part name as shown on the parts list. Also, give the caliber, model name, and serial number of your firearm.

Colt Rifle Inc.  
1024 Grafton Road  
Morgantown, WV 26508-4708  
Tel.: (800)241-1824

## SHIPPING YOUR FIREARM

Various federal and state laws and local ordinances govern the transfer and transportation of firearms, so take the advice of the dealer in your area on how to properly send or transport your firearm to Colt Rifles Inc.

Before shipping your firearm, please follow these important pointers:

- \* Make sure the magazine and chamber of the firearm are empty.
- \* Write a letter explaining the problem and your requirements, in as much detail as possible. Include the model name, serial number, and your return address and telephone number, then enclose the letter with the firearm in a well-padded package.
- \* Do not ship presentation boxes, accessories (such as scopes, slings, etc.), or explosive components.
- \* Do not indicate on the outside of the box its contents, and do not put Colt's name on the address, so that an inquisitive thief will not be attracted to your package.
- \* Always insure the package and its contents for the full value against loss, damage, or theft.

# TROUBLESHOOTING

## ACCURACY PROBLEM

From time to time, a rifle that once shot very well will begin to shoot poorly for no apparent reason. If this happens to you, there are some things you can do to determine what the cause of your accuracy problems are.

- Thoroughly clean your rifle as described in the "Cleaning Your Firearm" section of this manual. Each time a shot is fired, copper from the bullet is deposited on the inside of the barrel. Over time, this accumulation can cause accuracy to decline and may also create a dangerous situation by increasing pressure levels. By keeping your barrel clean, you are extending the life of your barrel.
- Try shooting your rifle with a different scope. Scope manufacturers do an excellent job of making scopes, but occasionally one will break through use, abuse, or neglect. If the second scope that you try yields no better accuracy, return the rifle to us immediately for our inspection. However, if using the second scope produces accuracy that you have come to expect, your accuracy problems are the result of a damaged scope. Colt recommends that you return the scope to the manufacturer for repair, since all scope manufacturers have excellent repair policies.

# NOTES



**LEAD WARNING:**

Discharging firearms in poorly ventilated areas, cleaning firearms, or handling ammunition may result in exposure to lead and other substances known to cause birth defects, reproductive harm, and other serious physical injuries.

Work in adequate ventilation at all times.

Wash hands thoroughly after exposure.

Colt's Manufacturing Company, Inc.  
Box 1868  
Hartford, Connecticut 06144-1868  
USA

SD p/n 13071